

# Check valve

## Type Z1S

**RE 21534**

Edition: 2015-08

Replaces: 02.09

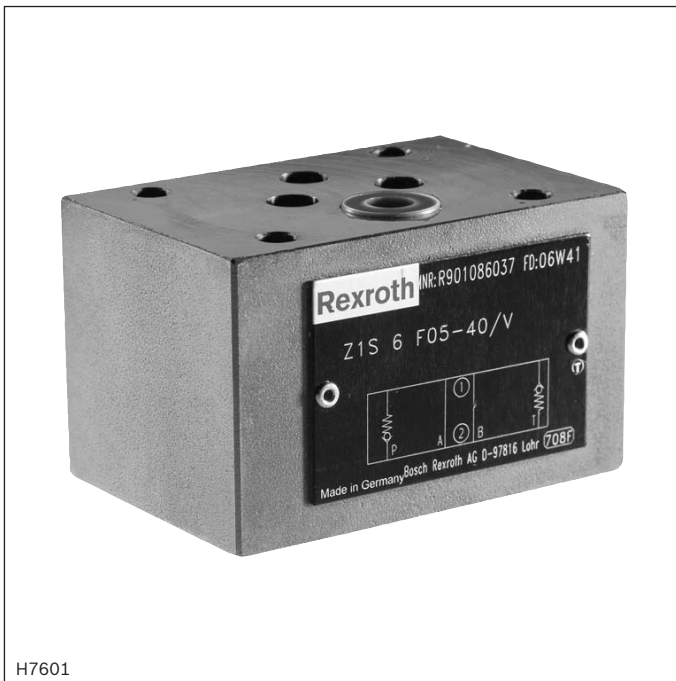

H7601

- ▶ Size 6
- ▶ Component series 4X
- ▶ Maximum operating pressure 350 bar [5076 psi]
- ▶ Maximum flow 40 l/min [10.6 US gpm]

### Features

- ▶ Sandwich plate valve for use in vertical stackings
  - as angle valve
  - as straight-through valve
- ▶ Porting pattern according to ISO 4401-03-02-0-05 and NFPA T3.5.1 R2-2002 D03
- ▶ Various one- and two-channel blocking functions
- ▶ Perfect leak-tightness due to poppet made of high-performance plastic
- ▶ Corrosion-resistant surface upon request
- ▶ Easily adjustable to special hydraulic fluids by exchanging the external seal rings
- ▶ With measuring ports, optional
- ▶ As throttle check valve upon request

### Contents

Features	1
Ordering codes	2
Symbols	3, 4
Function, sections	5
Technical data	6
Characteristic curves	7
Dimensions	8, 9
Notices	10
Troubleshooting	10
Check valve installation set: Disassembly and assembly	11
Additional information	11

**Ordering codes**

01	02	03	04	05	06	07	08	09	10
<b>Z1S</b>	<b>6</b>			<b>- 4X</b>	<b>/</b>	<b>V</b>	<b>/</b>		<b>*</b>

01	Check valve, sandwich plate	<b>Z1S</b>
02	Size 6	<b>6</b>

**Direction of flow**

03	<b>- Straight-through valve</b> (in the channel)	
	A (A2 → A1)	<b>A</b>
	B (B2 → B1)	<b>B</b>
	A (A1 → A2)	<b>C</b>
	B (B1 → B2)	<b>D</b>
	A and B (A1 → A2) and (B1 → B2)	<b>E</b>
	P and T (P2 → P1) and (T1 → T2)	<b>F</b>
	P (P2 → P1)	<b>P</b>
	T (T1 → T2)	<b>T</b>
	<b>- Angle valve</b>	
	B → A	<b>B-A</b>
	T → P	<b>T-P</b>
	AB → P	<b>AB-P</b>
	(For symbols, see page 3 and 4)	

**Cracking pressure**

04	0.5 bar [7.25 psi]	<b>05</b>
	1.5 bar [21.76 psi]	<b>15</b>
	3.0 bar [43.51 psi]	<b>30</b>
	5.0 bar [72.52 psi]	<b>50</b>
05	Component series 40 ... 49 (40 ... 49: Unchanged installation and mounting dimensions)	<b>4X</b>

**Seal material**

06	FKM seals	<b>V</b>
	Observe compatibility of seals with hydraulic fluid used. (Other seals upon request)	

**Corrosion resistance** (outside; thick film passivated according to DIN 50979 Fe//Zn8//Cn//T0)

07	None (valve housing primed)	<b>no code</b>
	Improved corrosion protection (240 h salt spray test according to EN ISO 9227)	<b>J3</b>
08	<b>Without</b> locating hole	<b>no code</b>
	<b>With</b> locating hole	<b>/60<sup>1)</sup></b>
	<b>With</b> locating hole and locking pin ISO 8752-3x8-St	<b>/62</b>

**Special version**

09	Standard version	<b>no code</b>
	Measuring port P (G1/4; on channel B side)	<b>SO68</b>
	Measuring port P (G1/4; on channel A side)	<b>SO118</b>
	Measuring port A and B (G1/4)	<b>SO90</b>
	Measuring port T (G1/4)	<b>SO2</b>
	Direction of flow P1 → P2 (opposite to version "P")	<b>SO104</b>
	For symbols (examples), see page 4	
10	Further details in the plain text	<b>*</b>

<sup>1)</sup> Locking pin ISO 8752-3x8-St, material no. **R900005694**  
(separate order)

**Symbols:** Straight-through valve (① = component side, ② = plate side)

Type Z1S 6 A...

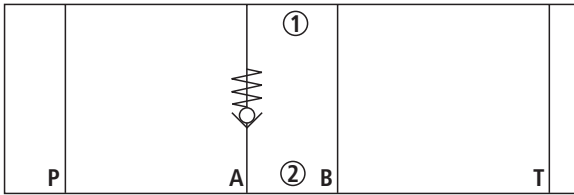

Type Z1S 6 D...

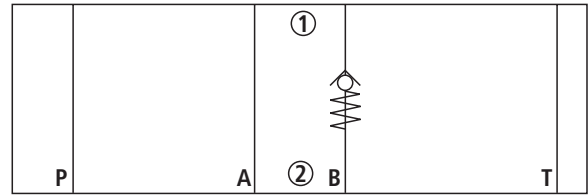

Type Z1S 6 P...

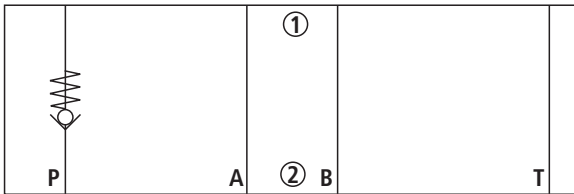

Type Z1S 6 B...

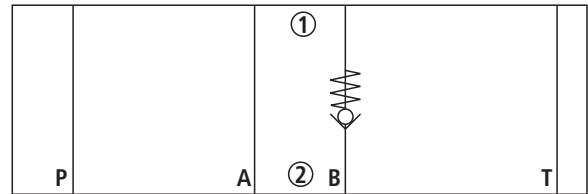

Type Z1S 6 E...

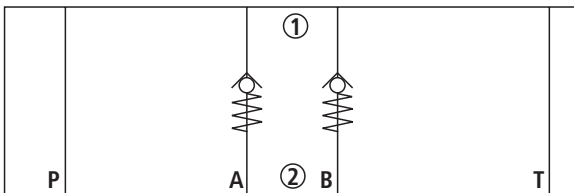

Type Z1S 6 T...

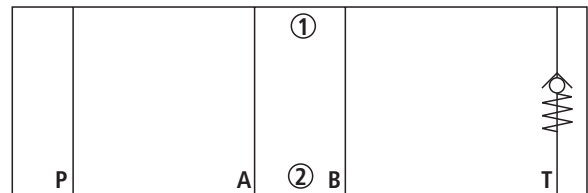

Type Z1S 6 C...

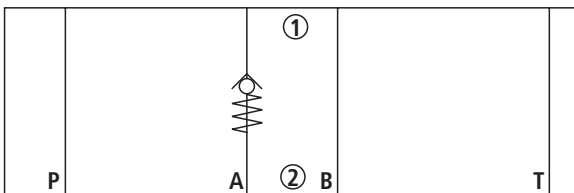

Type Z1S 6 F...

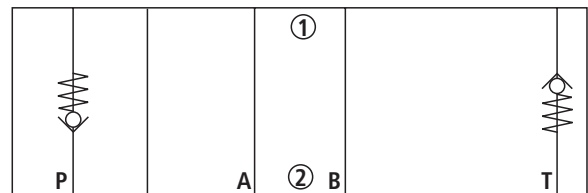

**Symbols:** Angle valve (① = component side, ② = plate side)

Type Z1S 6 AB-P...

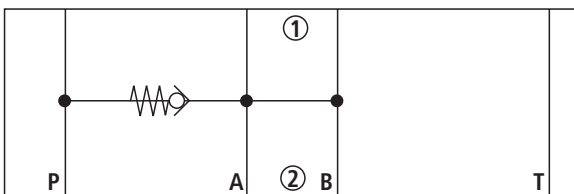

Type Z1S 6 T-P...

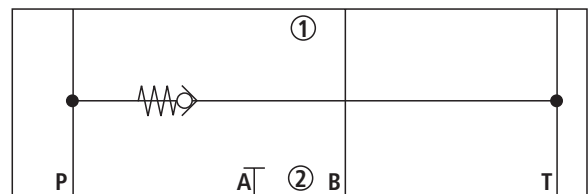

Type Z1S 6 B-A...

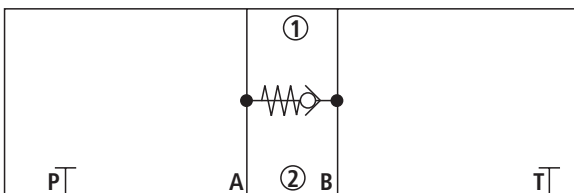

**Symbols:** Examples for special versions (① = component side, ② = plate side)

Type Z1S 6 P.-4X/...**SO68**

(check valve in channel P, measuring port P Out G1/4)

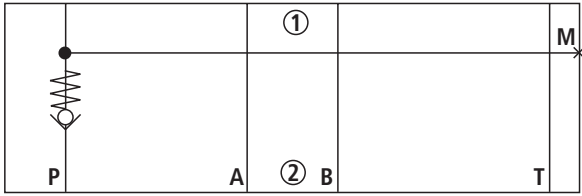

Type Z1S 6 P.-4X/...**SO118**

(check valve in channel P, measuring port P Out G1/4)

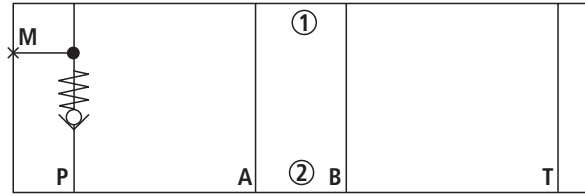

Type Z1S 6 P.-4X/...**SO90**

(check valve in channel P, measuring port A and B G1/4)

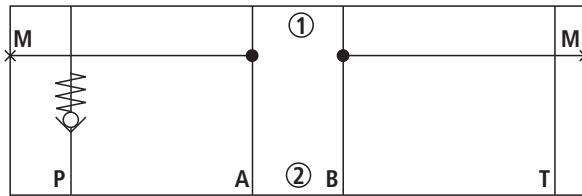

Type Z1S 6 P.-4X/...**SO2**

(check valve in channel P, measuring port T G1/4)

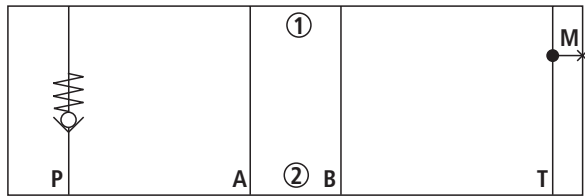

Type Z1S 6 P.-4X/...**SO104**

(check valve in channel P, direction of flow P1 → P2)

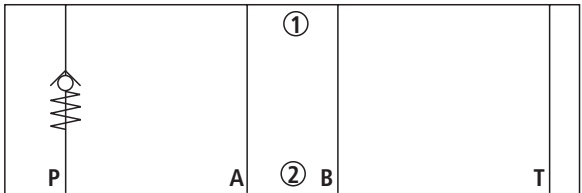

## Function, sections

The valve type Z1S is a direct operated check valve in sandwich plate design.

It is used for the leakage-free blocking in one direction and allows for free flow in the opposite direction.

The stroke of the poppet (1) is limited by the plastic socket (2). The installed spring (3) supports the closing movement. When no fluid flows through the valve, the spring (3) keeps the poppet (1) in closed position.

In contrast to the straight-through valve (section 1), the angle valve (section 2) links or closes off up to three internal channels. Stop and sealing function are taken over by the plug screw (4).

### Notice:

For all installation positions in which the blue plastic socket (2) is mounted at the plate side ②, no additional seal ring may be used at this position! At the component side ①, the seal ring (5) (as usual) seals the assembly installed downstream.

The installed plastic socket (2) has a sealing function and may not be removed or damaged.

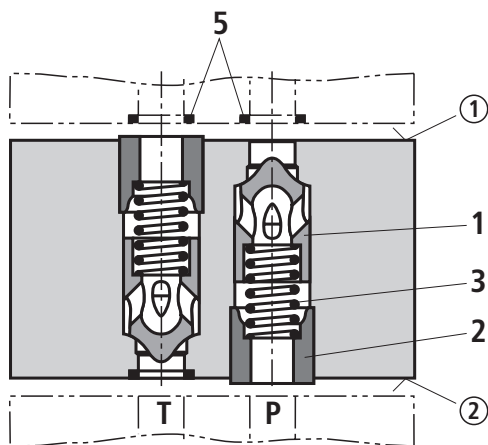

**Section 1: Type Z1S 6 F** (straight-through valve)

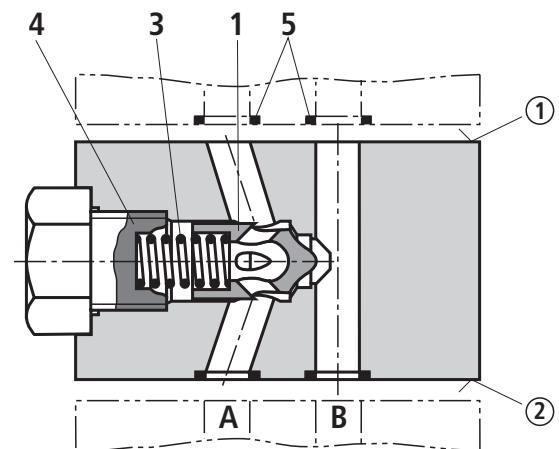

**Section 2: Type Z1S 6 BA** (angle valve)

**Technical data**

(For applications outside these parameters, please consult us!)

<b>general</b>		
Weight	kg [lbs]	Approx. 0.8 [1.76]
Installation position		Any
Ambient temperature range	°C [°F]	-20 ... +80 [-4 ... +176]

<b>hydraulic</b>		
Maximum operating pressure	bar [psi]	350 [5076]
Cracking pressure	bar [psi]	0.5; 1.5; 3; 5 [7.25; 21.76; 43.51; 72.52]
Maximum flow	l/min [US gpm]	40 [10.57]
Hydraulic fluid		See table below
Hydraulic fluid temperature range	°C [°F]	-20 ... +80 [-4 ... +176]
Viscosity range	mm <sup>2</sup> /s [SUS]	2.8 ... 500 [35 ... 2320]
Maximum admissible degree of contamination of the hydraulic fluid cleanliness class according to ISO 4406 (c)		Class 20/18/15 <sup>1)</sup>

Hydraulic fluid	Classification	Suitable sealing materials	Standards	Data sheet
Mineral oils	HL, HLP, HLPD, HVLP, HVLPD	NBR, FKM	DIN 51524	90220
Bio-degradable	▶ insoluble in water	HETG	ISO 15380	90221
		HEES		
	▶ soluble in water	HEPG	ISO 15380	
Flame-resistant	▶ water-free	HFDU, HFDR	ISO 12922	90222
	▶ containing water	HFC (Fuchs Hydrotherm 46M, Petrofer Ultra Safe 620)	ISO 12922	90223

**Important information on hydraulic fluids:**

- ▶ For more information and data on the use of other hydraulic fluids, please refer to the data sheets above or contact us!
- ▶ There may be limitations regarding the technical valve data (temperature, pressure range, life cycle, maintenance intervals, etc.)!
- ▶ The flash point of the hydraulic fluid used must be 40 K higher than the maximum solenoid surface temperature.

**▶ Flame-resistant – containing water:**

- Maximum pressure differential per control edge 50 bar
- Pressure pre-loading at the tank port > 20 % of the pressure differential, otherwise increased cavitation
- Life cycle as compared to operation with mineral oil HL, HLP 50 to 100 %

- ▶ **Bio-degradable and flame-resistant:** When using hydraulic fluids that are simultaneously zinc-solvent, zinc may accumulate (700 mg zinc per pole tube).

<sup>1)</sup> The cleanliness classes specified for the components must be adhered to in hydraulic systems. Effective filtration prevents faults and at the same time increases the life cycle of the components.

Available filters can be found at [www.boschrexroth.com/filter](http://www.boschrexroth.com/filter).

**Characteristic curves:** Straight-through valve  
(measured with HLP46,  $\vartheta_{oil} = 40 \pm 5 \text{ }^\circ\text{C}$  [ $104 \pm 9 \text{ }^\circ\text{F}$ ])

$\Delta p$ - $q_v$ -characteristic curves (A2 → A1)

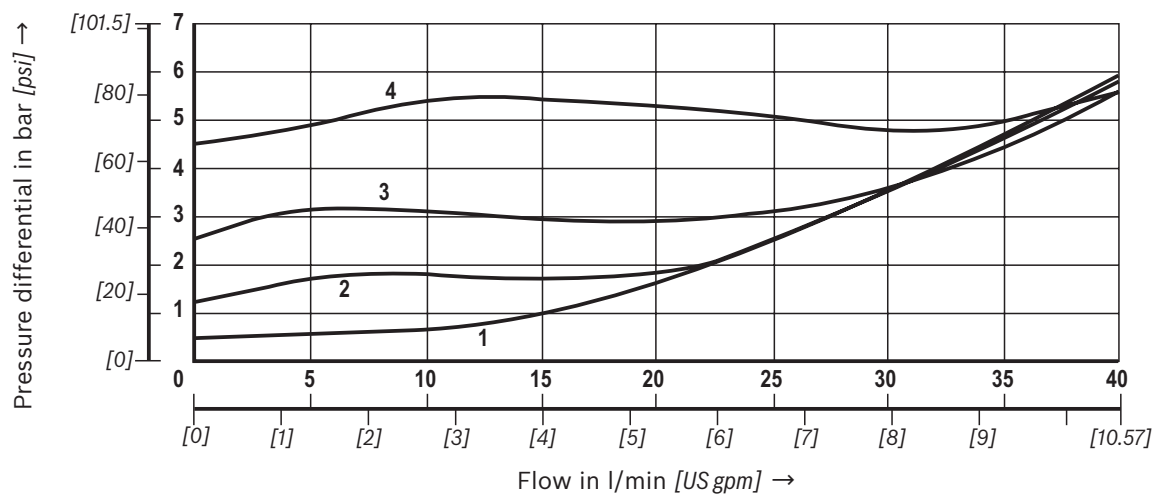

- 1 Cracking pressure 0.5 bar
- 2 Cracking pressure 1.5 bar
- 3 Cracking pressure 3 bar
- 4 Cracking pressure 5 bar

**Characteristic curves:** Angle valve  
(measured with HLP46,  $\vartheta_{oil} = 40 \pm 5 \text{ }^\circ\text{C}$  [ $104 \pm 9 \text{ }^\circ\text{F}$ ])

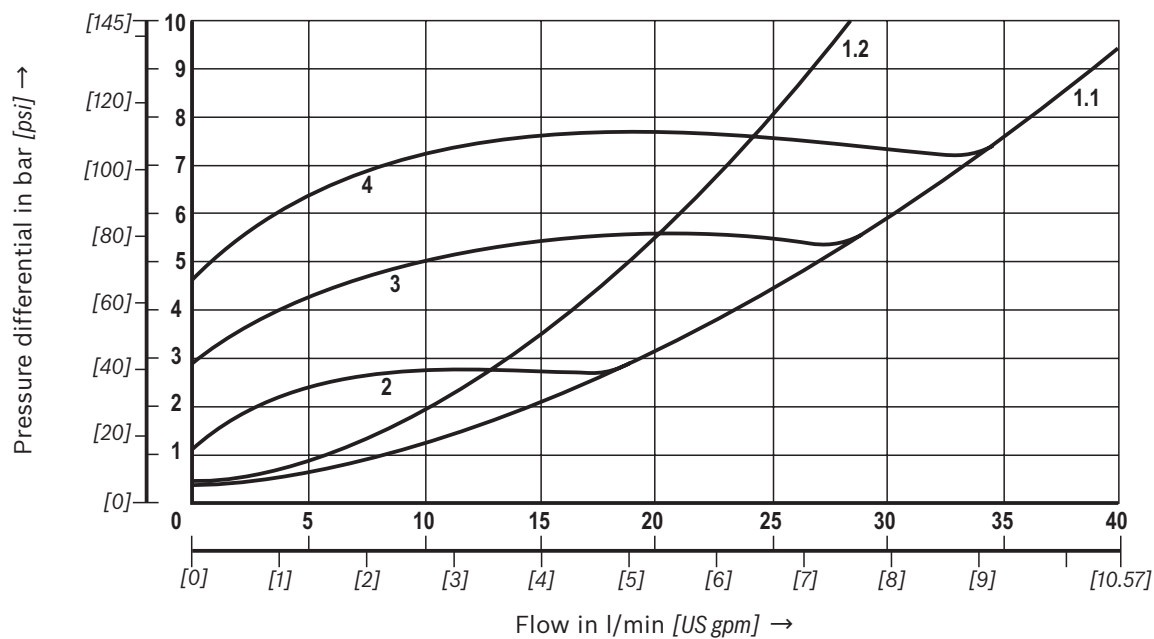

- 1.1 Cracking pressure 0.5 bar (B → P, B → A)
- 1.2 Cracking pressure 0.5 bar (A → P, T → P)
- 2 Cracking pressure 1.5 bar
- 3 Cracking pressure 3 bar
- 4 Cracking pressure 5 bar

**Dimensions:** Straight-through valve  
(dimensions in mm [inch])

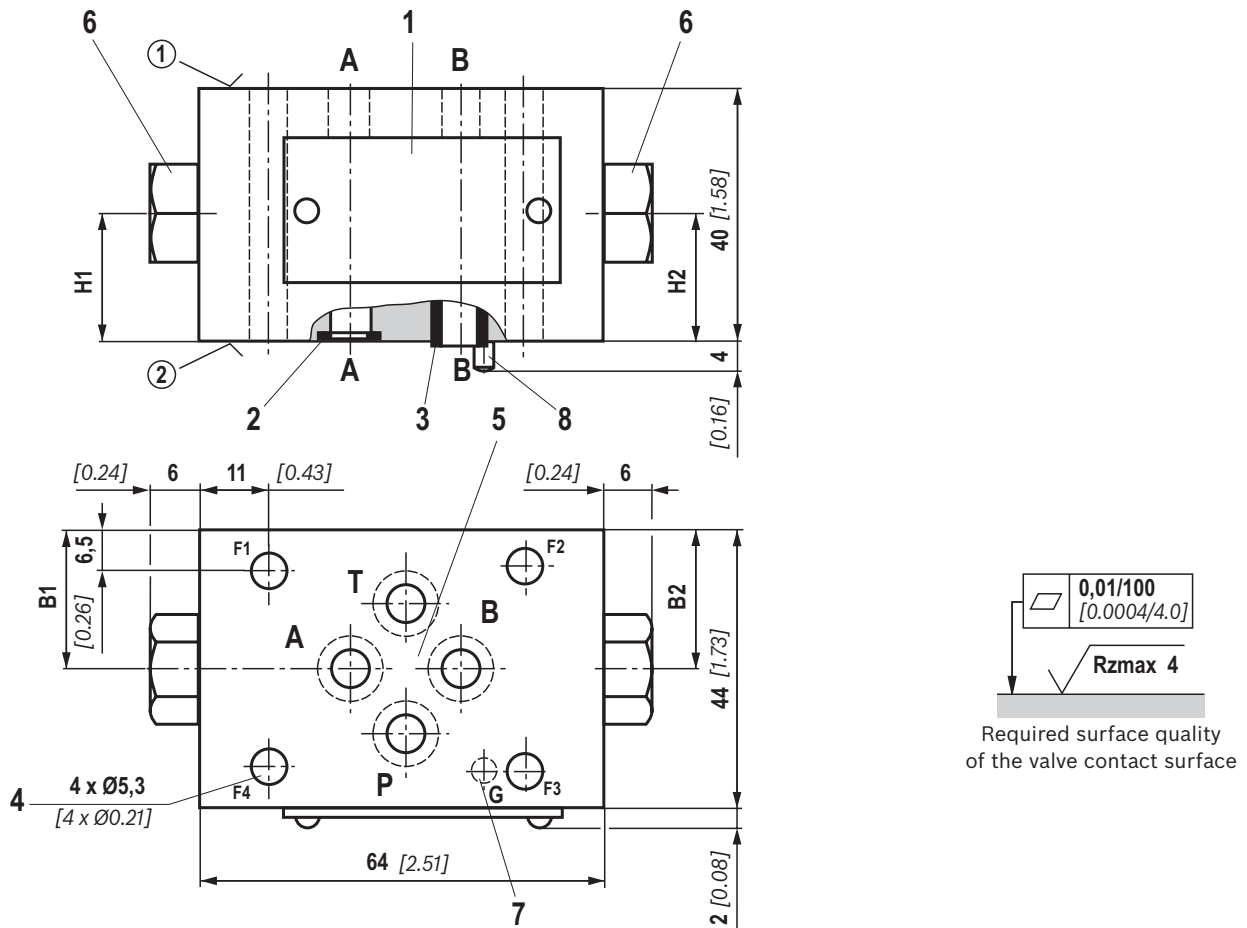

Type	B1	B2	H1	H2
Z1S 6 C...SO68	22 [0.87]	-	13.5 [0.53]	-
Z1S 6 P...SO68	-	26.5 [1.04]	-	13 [0.51]
Z1S 6 P...SO118	26.5 [1.04]	-	13 [0.51]	-
Z1S 6 P...SO90	22 [0.87]	22 [0.87]	20 [0.79]	20 [0.79]
Z1S 6 P...SO2	-	17.5 [0.69]	-	20 [0.79]

- 1 Name plate
- 2 Identical seal rings for ports A, B, P, T (plate side)
- 3 Plastic socket, blue (plate side)
- 4 Valve mounting bores
- 5 Porting pattern according to ISO 4401-03-02-0-05 and NFPA T3.5.1 R2-2002 D03
- 6 Plug screw for measuring port, tightening torque  $M_A = 30 \text{ Nm}$  [22.1 ft-lbs] +10 %
- 7 Locking pin ISO 8752-3x8-St (only version "60" and "62")
- 8 Bore for locking pin (only version "60" and "62")

**Valve mounting screws** (separate order)  
**4 hexagon socket head cap screws ISO 4762 - M5 - 10.9**

**4 hexagon socket head cap screws 10-24 UNC**

**Notice:**

The length of the valve mounting screws of the sandwich plate valve (screw-in depth  $\geq 10 \text{ mm}$  [inch]) must be selected according to the components mounted under and over the isolator valve. Depending on the application, screw type and tightening torque must be adjusted to the circumstances. Please ask Rexroth for screws with the required length.

- ① = component side
- ② = plate side



**Dimensions:** Angle valve  
(dimensions in mm [inch])

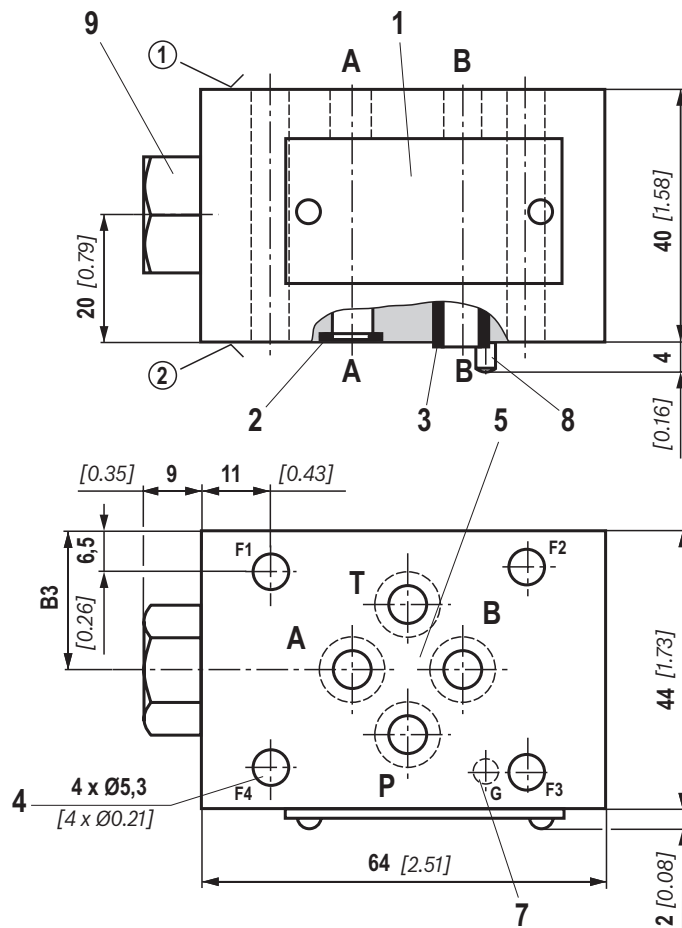

Design	B3
"AB-P"	24.5 [0.96]
"T-P"	24.5 [0.96]
"B-A"	22 [0.87]

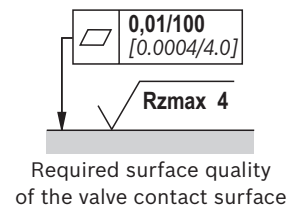

- 1 Name plate
- 2 Identical seal rings for ports A, B, P, T (plate side)
- 3 Plastic socket, blue (plate side)
- 4 Valve mounting bores
- 5 Porting pattern according to ISO 4401-03-02-0-05 and NFPA T3.5.1 R2-2002 D03
- 7 Locking pin ISO 8752-3x8-St (only version "60" and "62")
- 8 Bore for locking pin (only version "60" and "62")
- 9 Plug screw, tightening torque  $M_A = 55 \text{ Nm}$  [40.6 ft-lbs] +10 %

**Valve mounting screws** (separate order)

**4 hexagon socket head cap screws ISO 4762 - M5 - 10.9**

**4 hexagon socket head cap screws 10-24 UNC**

**Notice:**

The length of the valve mounting screws of the sandwich plate valve (screw-in depth  $\geq 10 \text{ mm}$  [inch]) must be selected according to the components mounted under and over the isolator valve. Depending on the application, screw type and tightening torque must be adjusted to the circumstances.

Please ask Rexroth for screws with the required length.

① = component side

② = plate side

## Notices

- ▶ Valve housing (steel) and plastic spool with plastic socket can be disassembled into individual components for proper disposal.
- ▶ The check valve installation set is available separately (plastic socket, plastic spool, spring):  
Email: spare.parts@boschrexroth.de
- ▶ The plastic socket has a sealing function and may therefore not be damaged!
- ▶ For installation and disassembly of the check valve installation set, a special multi-purpose tool is required, see page 11.

## Troubleshooting

External leakage at the flow passages	Seal ring faulty.	Replace seal rings (seal kit).
	Lip of the plastic socket is damaged.	Replace check valve installation set. <sup>1)</sup>
	Mounting screws tightened unevenly.	Loosen screws and tighten them again crosswise using the recommended tightening torque.
Internal leakage at the check valve installation set	Foreign particle on poppet surface.	Check poppet surface from the outside for foreign particles and remove them.
	Poppet does not move freely.	Check free movement of the poppet from the outside using an appropriate mandrel. Caution - do not push the plastic socket out of the housing!
	Leakage caused by downstream assembly.	Check if the check valve installation set is the reason for the leakage.
	Hydraulic fluid quality does not correspond to the specification.	Check hydraulic fluid quality and adjust it to the specifications, if required.
	Dependent on the included hydraulic fluid volume and its temperature variations, there may be pressure changes which are not due to leakage.	
	If the measures described above are not successful:	Completely replace the check valve installation set. <sup>1)</sup>
External leakage at measuring ports	Seal faulty.	Replace profile seal.
	Plug screw or fitting not tightened correctly.	Tighten plug screw or fitting using the specified tightening torque.

<sup>1)</sup> Use the special multi-purpose tool to avoid damaging the plastic socket, see page 11!

## Check valve installation set: Disassembly and assembly

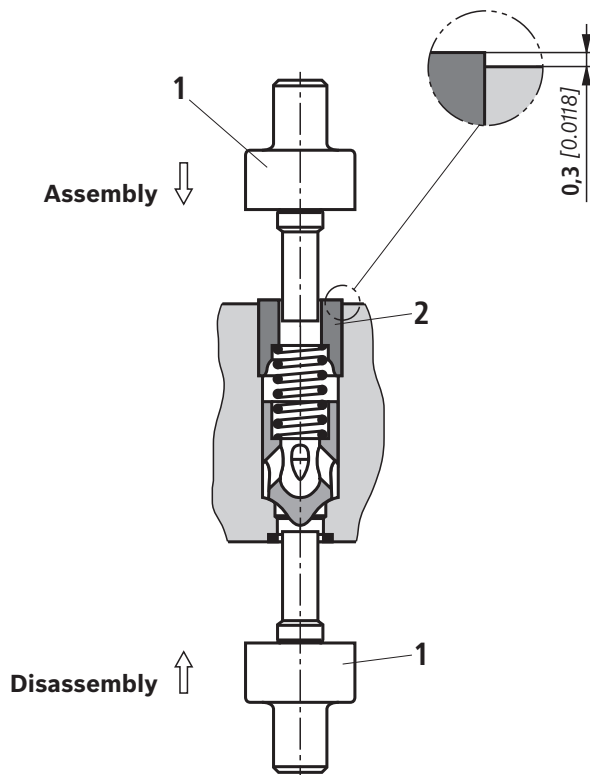

Disassembly/assembly without causing damage is achieved by using the special multi-purpose tool (1) (separate order, material no. **R901182853**).

### Disassembly:

Push out the check valve installation set.

### Assembly:

Insert the check valve installation set and push in the plastic socket (2).

With correct assembly using the special multi-purpose tool (1), the protrusion of the plastic socket (2) is approx. 0.3 mm [0.0118 inch].

### Notice:

Once removed, plastic sockets may no not be used again.

## Additional information

- ▶ Sandwich plates size 6
- ▶ Hydraulic fluids on mineral oil basis
- ▶ Environmentally compatible hydraulic fluids
- ▶ Flame-resistant, water-free hydraulic fluids
- ▶ Flame-resistant hydraulic fluids - containing water (HFAE, HFAS, HFB, HFC)
- ▶ Reliability characteristics according to EN ISO 13849
- ▶ Hexagon socket head cap screw, metric/UNC
- ▶ Hydraulic valves for industrial applications
- ▶ General product information on hydraulic products
- ▶ Assembly, commissioning and maintenance of industrial valves
- ▶ Selection of filters
- ▶ Information on available spare parts

Data sheet 48052

Data sheet 90220

Data sheet 90221

Data sheet 90222

Data sheet 90223

Data sheet 08012

Data sheet 08936

Operating instructions 07600-B

Data sheet 07008

Data sheet 07300

[www.boschrexroth.com/filter](http://www.boschrexroth.com/filter)

[www.boschrexroth.com/spc](http://www.boschrexroth.com/spc)

## Notes

Bosch Rexroth AG  
Hydraulics  
Zum Eisengießer 1  
97816 Lohr am Main, Germany  
Phone +49 (0) 93 52/ 18-0  
documentation@boschrexroth.de  
www.boschrexroth.de

© This document, as well as the data, specifications and other information set forth in it, are the exclusive property of Bosch Rexroth AG. It may not be reproduced or given to third parties without its consent.  
The data specified above only serve to describe the product. No statements concerning a certain condition or suitability for a certain application can be derived from our information. The information given does not release the user from the obligation of own judgment and verification. It must be remembered that our products are subject to a natural process of wear and aging.